

2 PLAN @ LEVEL 1B
SCALE: 3/16"=1'-0"

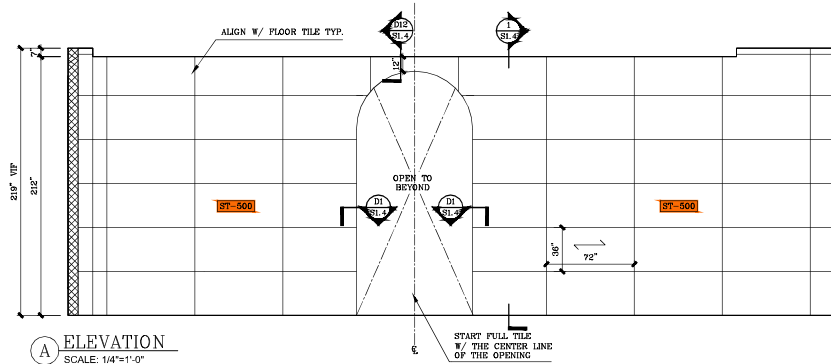

A ELEVATION
SCALE: 1/4"=1'-0"

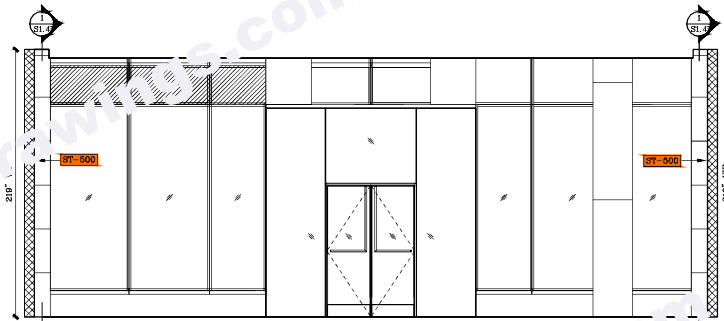

B ELEVATION
SCALE: 1/4"=1'-0"

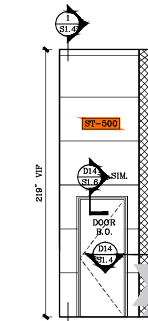

C ELEVATION
SCALE: 1/4"=1'-0"

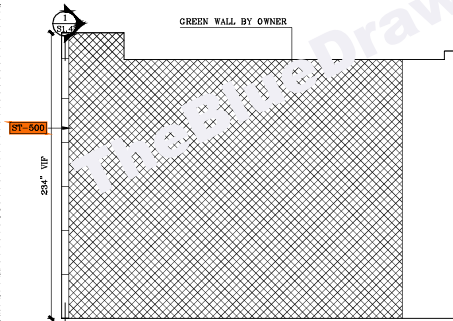

D ELEVATION
SCALE: 1/4"=1'-0"

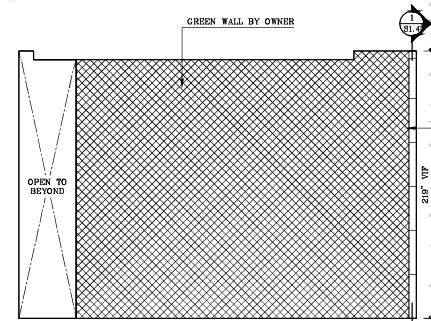

E ELEVATION
SCALE: 1/4"=1'-0"

SPECIFICATIONS

FINISHES

ST-500 TRAVERTINE - MARE CLASSICO HONED

HARDWARE

FIXTURES

APPROVED/NO CHANGES
APPROVED/AS NOTED
REVISE AS NOTED/RESUBMIT

SIGNATURE _____ DATE _____

REVISIONS

NO.	DATE	DESCRIPTION	BY	OBS.
1	11/05/24	ARCHIT. REVISION	DAN	
2	05/15/25	ARCHIT. REVISION	DAN	
3	07/11/25	REVISION AS PER BULLETIN RPT 732	DAN	
4	02/11/26	REVISION AS PER RESOLANS	DAN	
5	05/20/26	REVISION AS ACTUAL TILE SIZE	DAN	

APPROVED BY:

DATE

PROJECT INFORMATION

NO.	DESCRIPTION	BY	OBS.
1	PROJECT	DAN	
2	DATE	DAN	
3	LOCATION	DAN	
4	OWNER	DAN	
5	DESIGNER	DAN	
6	DATE	DAN	
7	SCALE	DAN	
8	PROJECT	DAN	
9	DATE	DAN	
10	LOCATION	DAN	
11	OWNER	DAN	
12	DESIGNER	DAN	
13	DATE	DAN	
14	SCALE	DAN	
15	PROJECT	DAN	
16	DATE	DAN	
17	LOCATION	DAN	
18	OWNER	DAN	
19	DESIGNER	DAN	
20	DATE	DAN	
21	SCALE	DAN	
22	PROJECT	DAN	
23	DATE	DAN	
24	LOCATION	DAN	
25	OWNER	DAN	
26	DESIGNER	DAN	
27	DATE	DAN	
28	SCALE	DAN	
29	PROJECT	DAN	
30	DATE	DAN	
31	LOCATION	DAN	
32	OWNER	DAN	
33	DESIGNER	DAN	
34	DATE	DAN	
35	SCALE	DAN	
36	PROJECT	DAN	
37	DATE	DAN	
38	LOCATION	DAN	
39	OWNER	DAN	
40	DESIGNER	DAN	
41	DATE	DAN	
42	SCALE	DAN	
43	PROJECT	DAN	
44	DATE	DAN	
45	LOCATION	DAN	
46	OWNER	DAN	
47	DESIGNER	DAN	
48	DATE	DAN	
49	SCALE	DAN	
50	PROJECT	DAN	

PROJECT: HUDSON'S TOWER
LOCATION: DETROIT, MICHIGAN

OWNER: COVERING STORE COMPANY

LEVEL 1

DATE: 11/05/24
SCALE: AS NOTED
PROJECT: HUDSON'S TOWER
LOCATION: DETROIT, MICHIGAN
OWNER: COVERING STORE COMPANY
LEVEL 1

DATE: 11/05/24
SCALE: AS NOTED
PROJECT: HUDSON'S TOWER
LOCATION: DETROIT, MICHIGAN
OWNER: COVERING STORE COMPANY
LEVEL 1

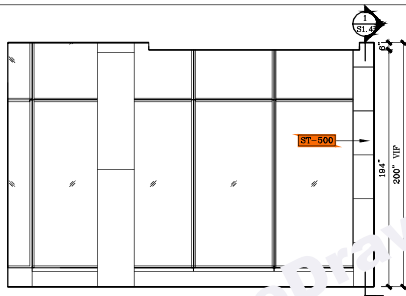

F ELEVATION
SCALE: 1/4"=1'-0"

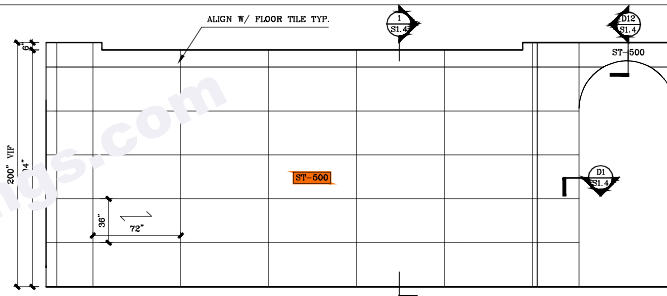

G ELEVATION
SCALE: 1/4"=1'-0"

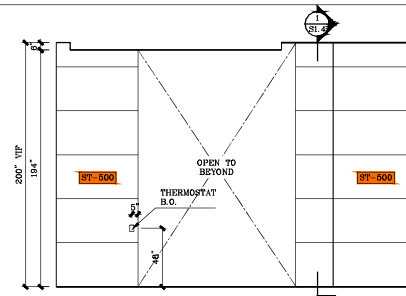

H ELEVATION
SCALE: 1/4"=1'-0"

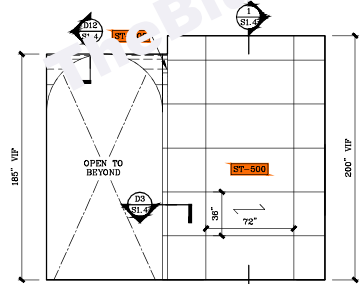

J ELEVATION
SCALE: 1/4"=1'-0"

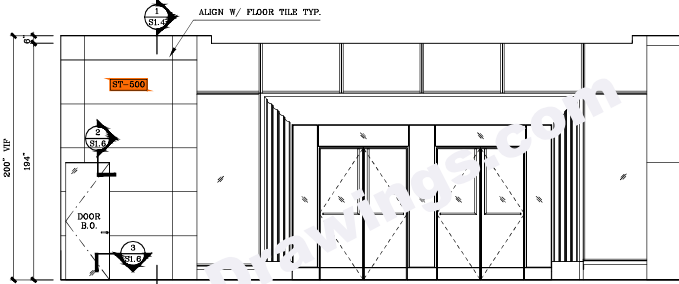

K ELEVATION
SCALE: 1/4"=1'-0"

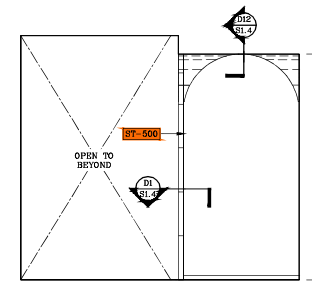

L ELEVATION
SCALE: 1/4"=1'-0"

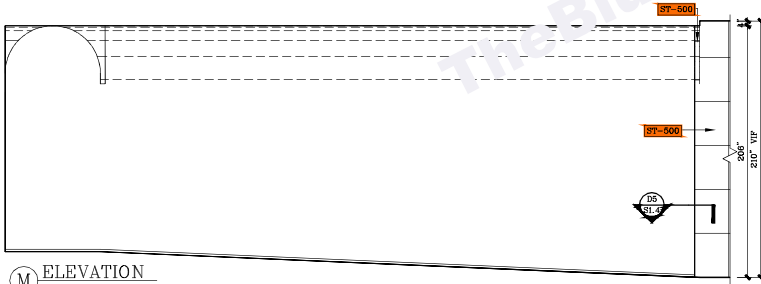

M ELEVATION
SCALE: 1/4"=1'-0"

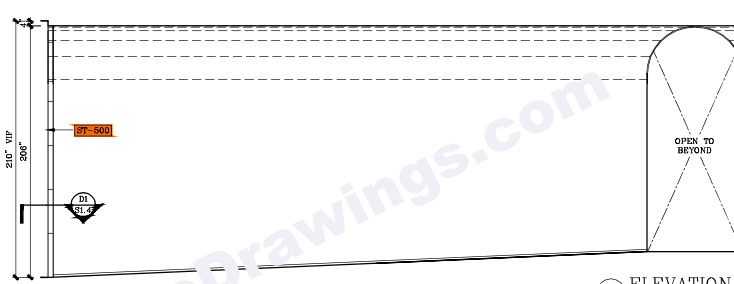

N ELEVATION
SCALE: 1/4"=1'-0"

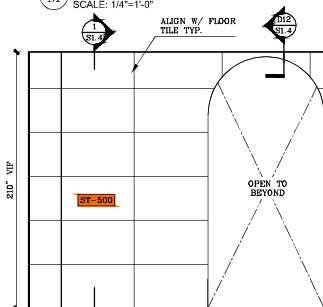

O ELEVATION
SCALE: 1/4"=1'-0"

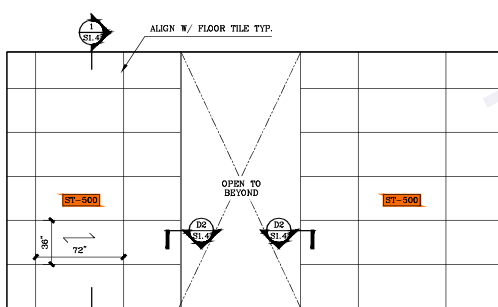

P ELEVATION
SCALE: 1/4"=1'-0"

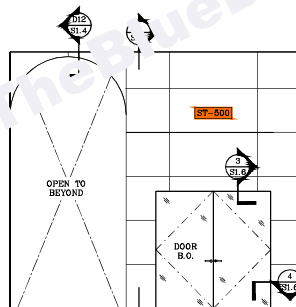

Q ELEVATION
SCALE: 1/4"=1'-0"

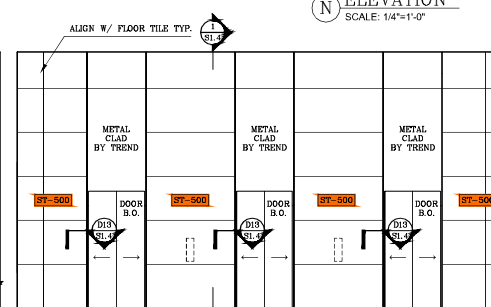

R ELEVATION
SCALE: 1/4"=1'-0"

SPECIFICATIONS

FINISHES

ST-500 TRAVERTINE - MARE CLASSICO HONED

HARDWARE

FIXTURES

APPROVED/NO CHANGES
APPROVED/AS NOTED
REVISE AS NOTED/RESUBMIT

SIGNATURE _____ DATE _____

REVISIONS

NO.	DATE	DESCRIPTION	BY	OBS.
1	11/05/24	ARCHT. REVISION	DAN	
2	05/15/25	ARCHT. REVISION	DAN	
3	07/11/25	REVISION AS PER BULLETIN RPT 732	DAN	
4	02/11/26	REVISION AS PER RESOLVES	DAN	
5	05/20/26	REVISION AS ACTUAL TILE SIZE	DAN	

APPROVED BY:

DATE: _____

HUDSON'S TOWER
DETROIT, MICHIGAN

COVERING STONE
COMPANY

LEVEL 1

DAN SCALE: AS NOTED

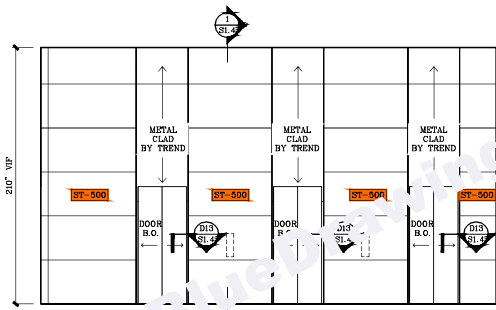

S ELEVATION
SCALE: 1/4"=1'-0"

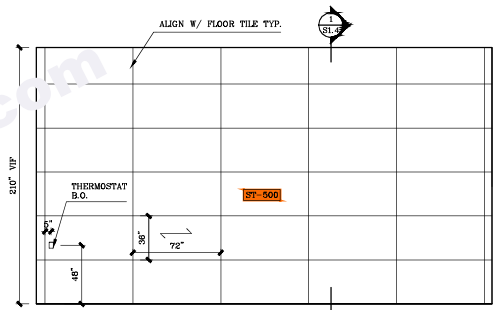

T ELEVATION
SCALE: 1/4"=1'-0"

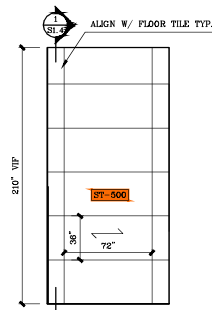

U ELEVATION
SCALE: 1/4"=1'-0"

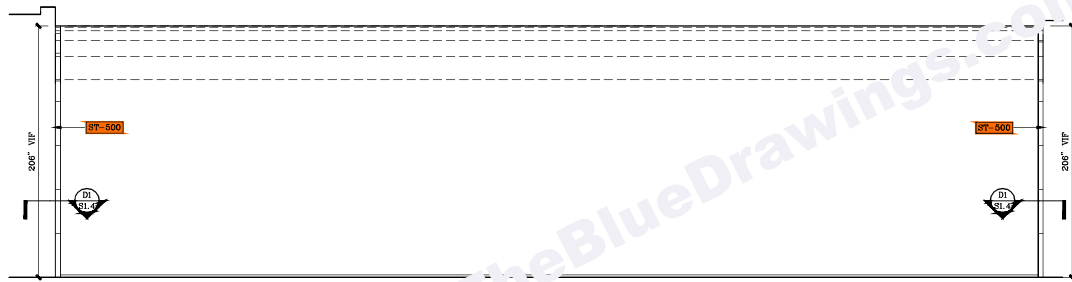

W ELEVATION
SCALE: 1/4"=1'-0"

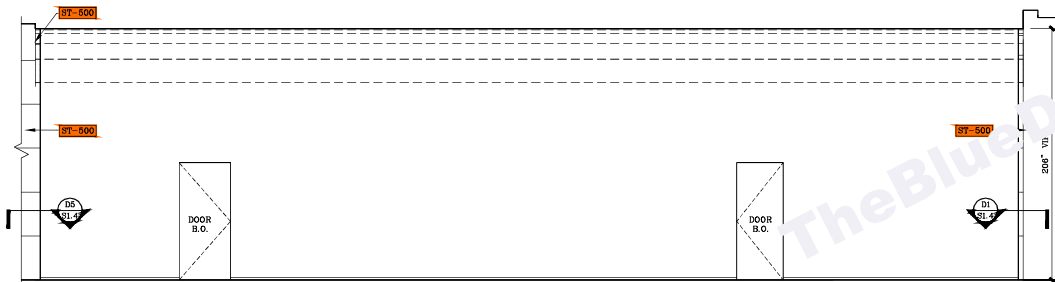

X ELEVATION
SCALE: 1/4"=1'-0"

SPECIFICATIONS

FINISHES

ST-500 TRAVERTINE - MARE CLASSICO HONED

HARDWARE

FIXTURES

APPROVED/NO CHANGES
APPROVED/AS NOTED
REVISE AS NOTED/RESUBMIT

SIGNATURE _____ DATE _____

REVISIONS

NO.	DATE	DESCRIPTION	BY	OBS.
1	11/05/24	ARCHT. REVISION	DAN	
2	10/15/24	ARCHT. REVISION	DAN	
3	07/11/24	REVISION AS PER BULLETIN #172	DAN	
4	02/11/24	REVISION AS PER RESOLNS	DAN	
5	10/29/23	REVISION AS ACTUAL TILE SIZE	DAN	

APPROVED BY:

DATE REVISIONS:

NO.	DATE	DESCRIPTION	BY	OBS.
1				
2				
3				
4				
5				

PROJECT: HUDSON'S TOWER
DETROIT, MICHIGAN

COVERING STORE COMPANY

LEVEL 1

DATE: 11/05/24
DRAWN BY: DAN
CHECKED BY: AS NOTED
DATE: 11/05/24

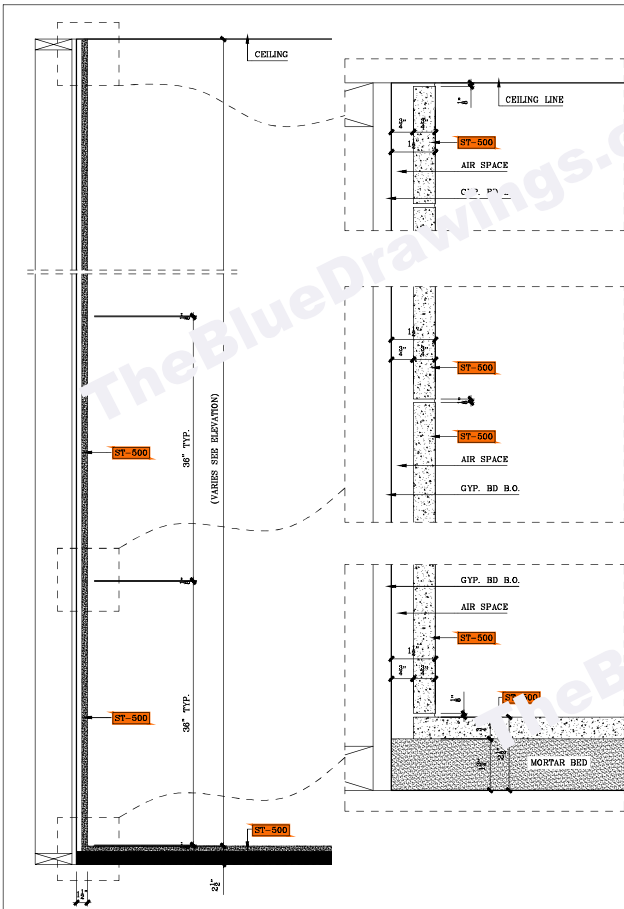

① VERTICAL SECTION
SCALE: 1 1/2"=1'-0"

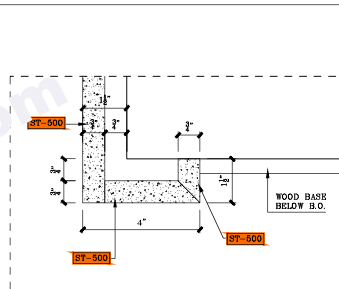

① PLAN DETAIL
SCALE: 6"=1'-0"

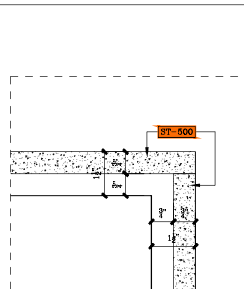

② PLAN DETAIL
SCALE: 6"=1'-0"

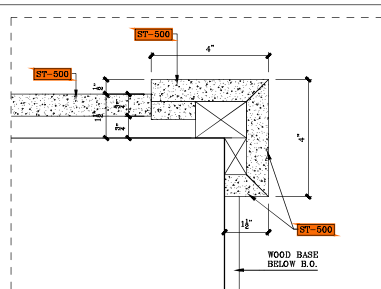

③ PLAN DETAIL
SCALE: 6"=1'-0"

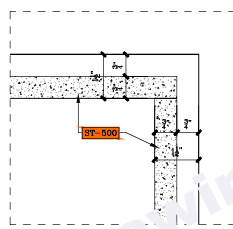

④ PLAN DETAIL
SCALE: 6"=1'-0"

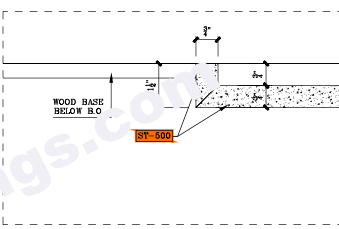

⑤ PLAN DETAIL
SCALE: 6"=1'-0"

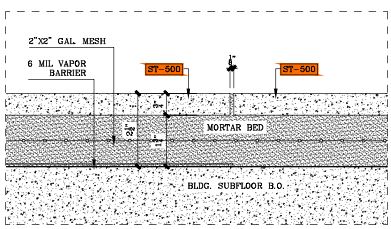

⑥ VERTICAL DETAIL
SCALE: 6"=1'-0"

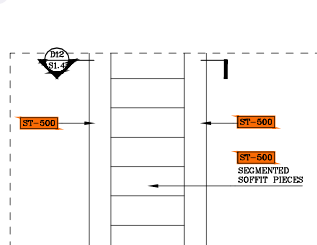

⑪ REPL. CLG. PLAN PORTAL
SCALE: 6"=1'-0"

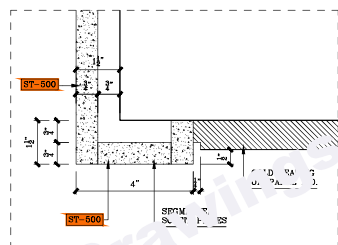

⑫ VERTICAL DETAIL
SCALE: 6"=1'-0"

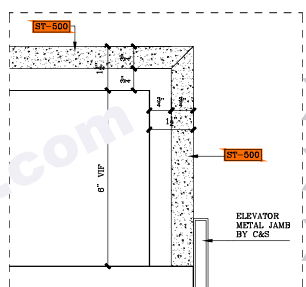

⑬ PLAN DETAIL
SCALE: 6"=1'-0"

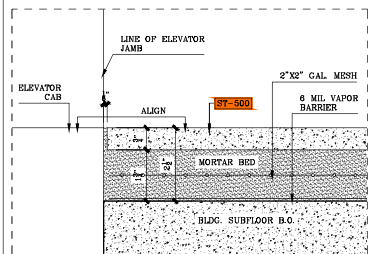

⑦ VERTICAL DETAIL
SCALE: 6"=1'-0"

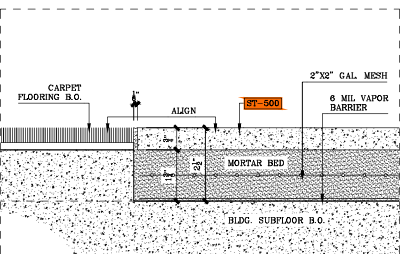

⑧ VERTICAL DETAIL
SCALE: 6"=1'-0"

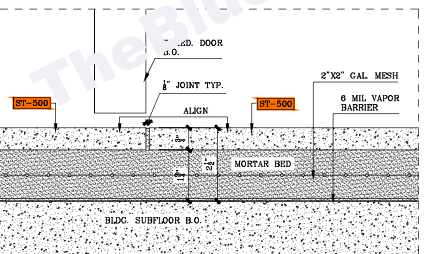

⑨ VERTICAL DETAIL
SCALE: 6"=1'-0"

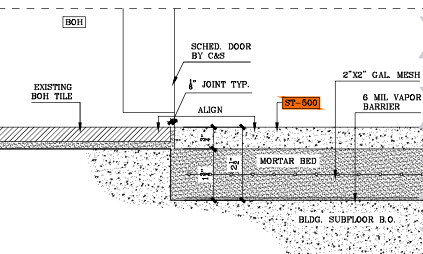

⑩ VERTICAL DETAIL
SCALE: 6"=1'-0"

SPECIFICATIONS				
FINISHES				
ST-500	TRAVERTINE - MARE CLASSICO HONED			
HARDWARE				
FIXTURES				
APPROVED/NO CHANGES				
APPROVED/AS NOTED				
REVISE AS NOTED/RESUBMIT				
SIGNATURE	DATE			
REVISIONS				
NO.	DATE	DESCRIPTION	BY	OBS.
1	11/05/24	ARCHIT. REVISION	DAN	
2	05/15/25	ARCHIT. REVISION	DAN	
3	07/11/25	REVISION AS PER BULLETIN RPT 732	DAN	
4	02/11/26	REVISION AS PER RESOLNS	DAN	
5	05/20/26	REVISION AS ACTUAL TILE SIZE	DAN	

APPROVED BY:
DATE

REVISIONS

HUDSON'S TOWER
DETROIT, MICHIGAN

COVERING STONE COMPANY
LEVEL 1

DATE: 11/05/24
SCALE: AS NOTED

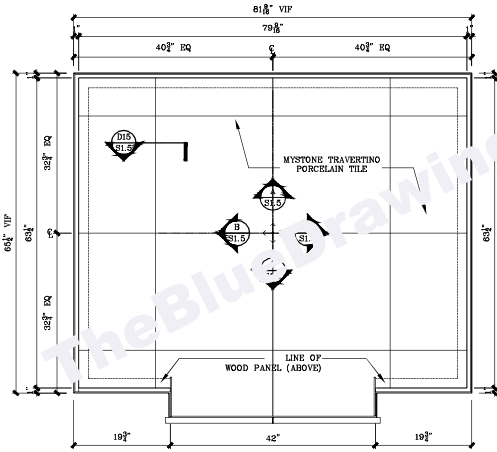

1 PLAN @ ELEVATOR CAB
SCALE: 1"=1'-0"

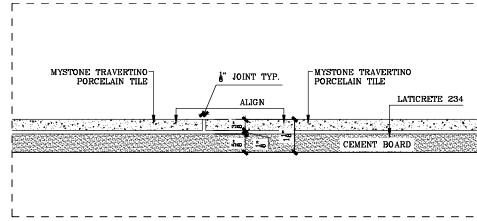

D15 VERTICAL DETAIL
SCALE: 6"=1'-0"

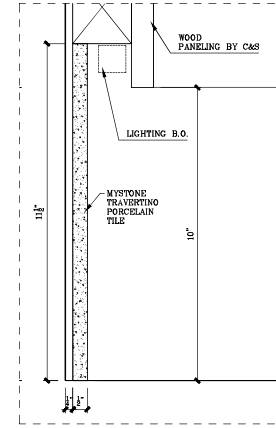

D16 VERTICAL DETAIL
SCALE: 6"=1'-0"

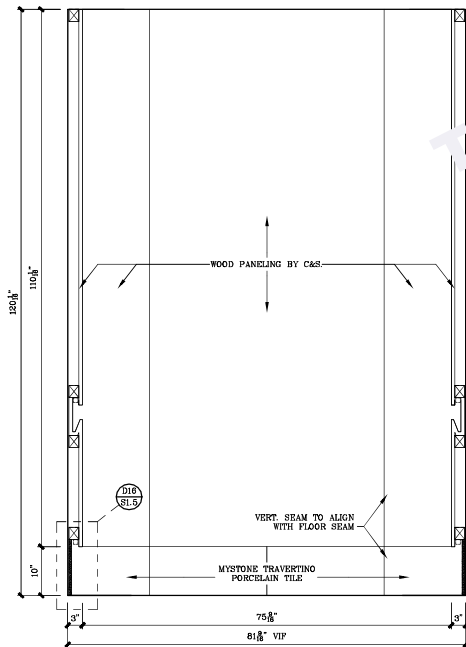

A ELEVATION
SCALE: 1"=1'-0"

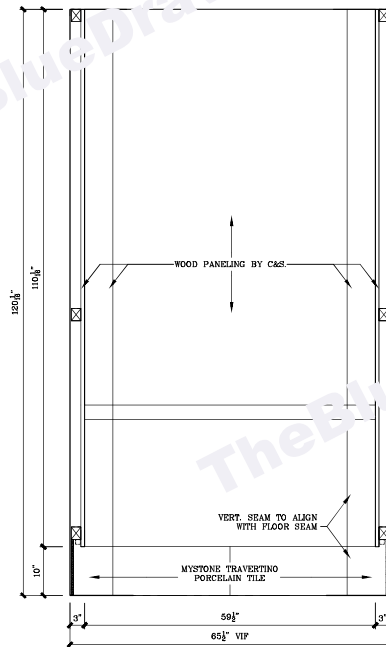

B ELEVATION
SCALE: 1"=1'-0"

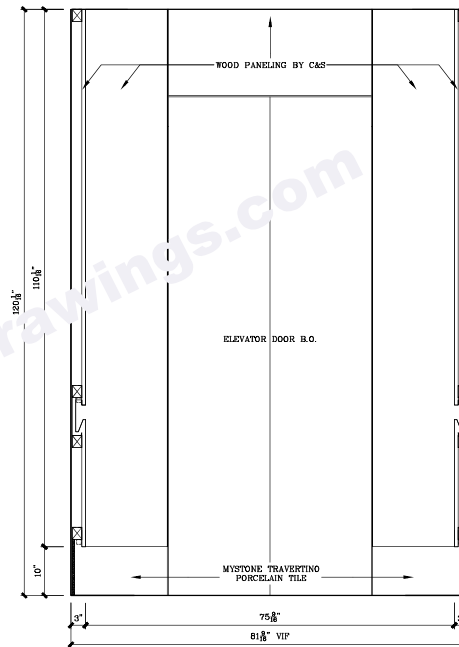

C ELEVATION
SCALE: 1"=1'-0"

SPECIFICATIONS

FINISHES

ST-500 TRAVERTINE - MARE CLASSICO HONED

HARDWARE

FIXTURES

APPROVED/NO CHANGES
APPROVED/AS NOTED
REVISE AS NOTED/RESUBMIT

SIGNATURE _____ DATE _____

REVISIONS

NO.	DATE	DESCRIPTION	BY	OBS.
1	11/05/24	ARCHIT. REVISION	DAN	
2	05/15/25	ARCHIT. REVISION	DAN	
3	07/11/25	REVISION AS PER BULLETIN RPT 732	DAN	
4	02/11/26	REVISION AS PER RESUBMIT	DAN	
5	05/29/26	REVISION AS ACTUAL TILE SIZE	DAN	

APPROVED BY:

DATE: _____

PROJECT: HUDSON'S TOWER

DETROIT, MICHIGAN

COVERING STONE COMPANY

LEVEL 1

SCALE: AS NOTED

DATE: 05/15/25

BY: DAN

